

Angel 1.1

Tadashi Mori

facebook.com/tadashiorigami

youtube.com/tadashimori

origamiyard.com

Recommended paper: Traditional origami paper (kami)

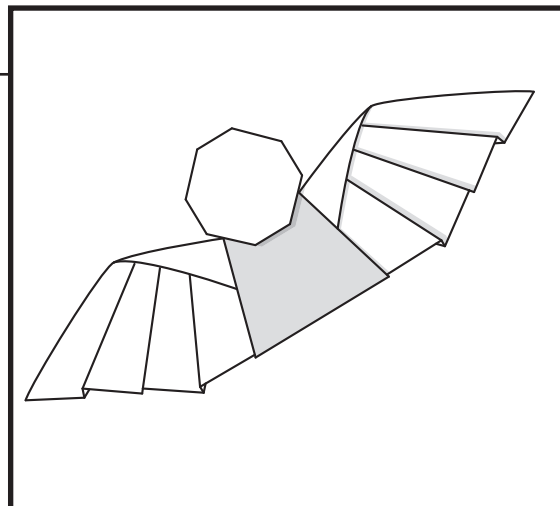

1.

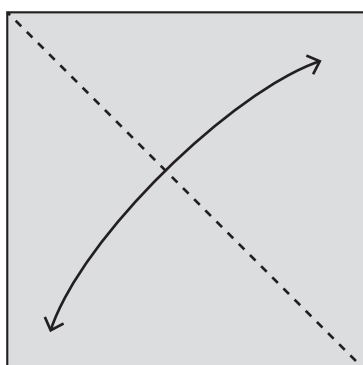

2.

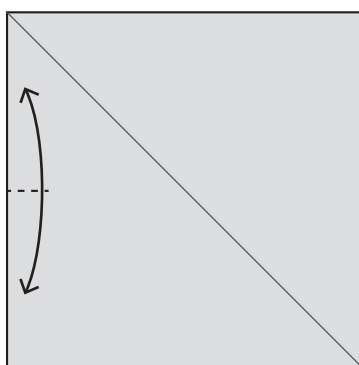

3.

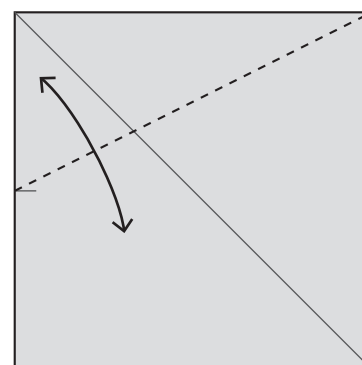

4.

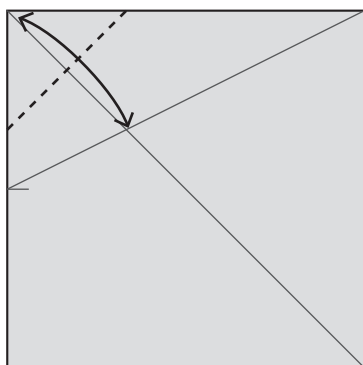

5.

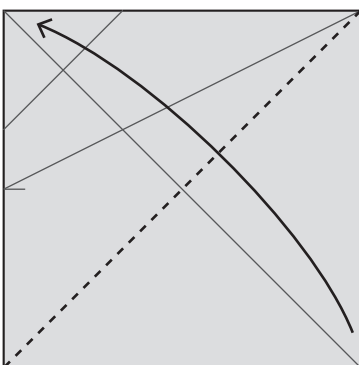

6.

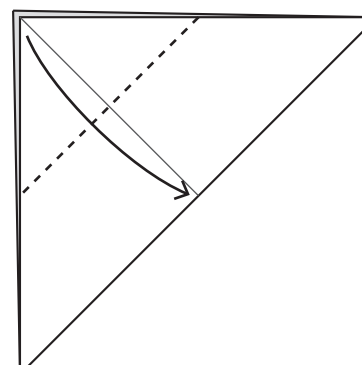

7.

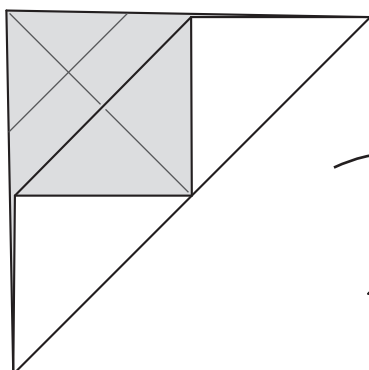

8.

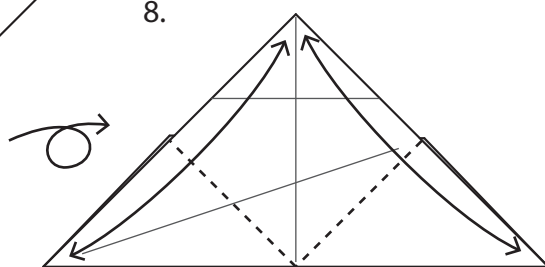

9.

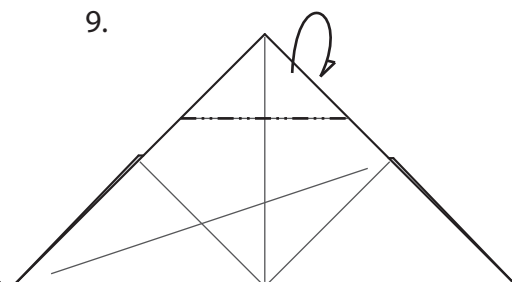

10.

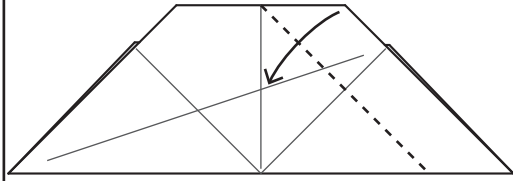

11. Fold the inner layers.

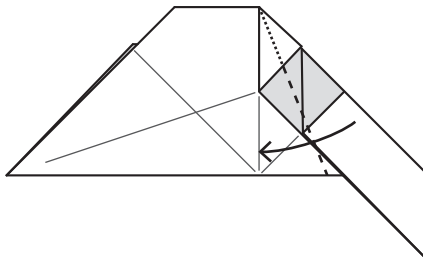

12. Unfold the last two steps.

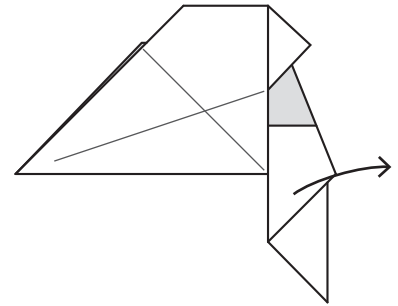

13.

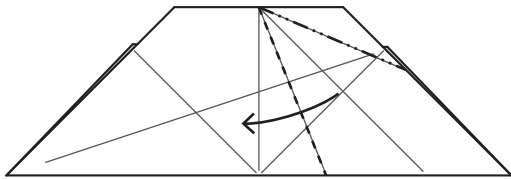

14.

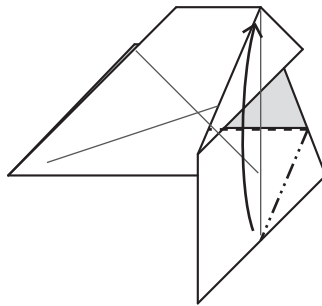

15. Fold the top layers. The model will not lie flat.

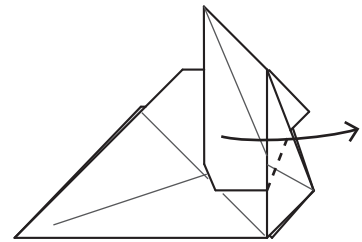

16.

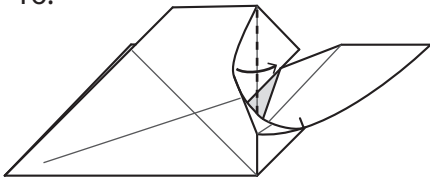

17.

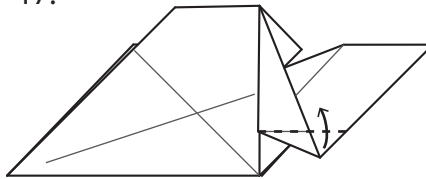

18. Repeat steps 10 - 17 on the other side.

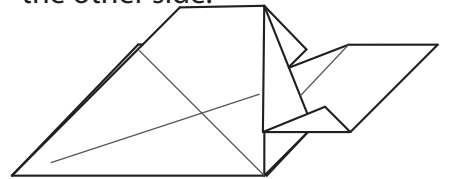

10-17 ↗

19. Turn the model over.

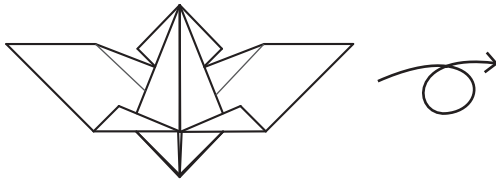

20. Fold the front layer to inside the gap.

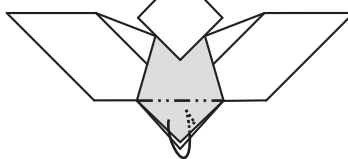

21.

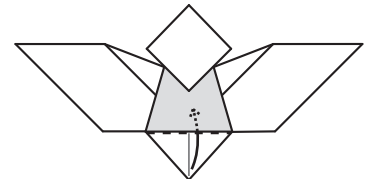

22. Fold the corners of the head.

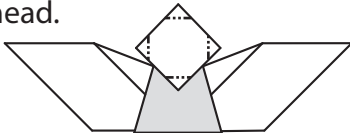

23.

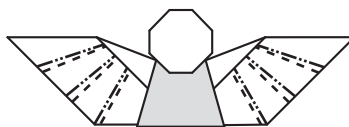

24. Done!

